

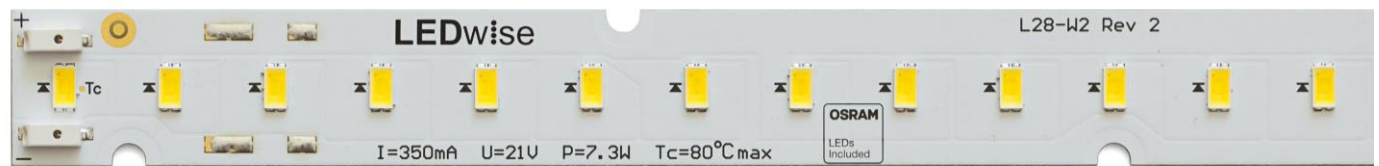

Technical Specification

L28-W2

Product Name:	L28-W2
Category:	Linear LED Module
Description:	Zhaga compliant 280mm linear LED Module



Features: 	High performance LEDs from Osram	Applications: Fluorescent Replacement
	Zhaga compliant	
	Power Consumption = 7.3 W/module (DC) @ 350mA	
	Lumen Output = 1185 lumens/module @ 350mA	
	L80 > 50,000 hours at Tc = 80°Celsius	
	2059 series Push in Wago™ connectors	
	Available in Cool, Natural and Warm White	
	Locally designed and manufactured	
CRI 90 and custom CCTs available on request		

Dimensions

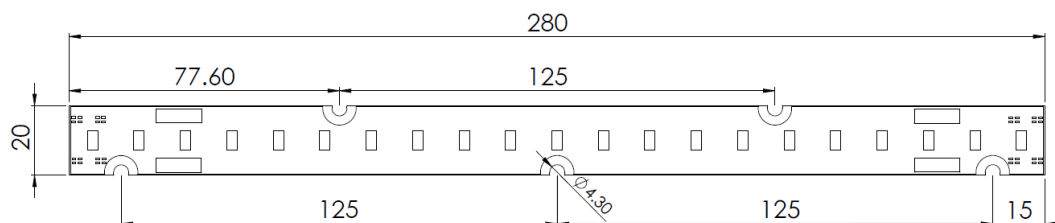

Product Code	Width (mm)	Length (mm)	Thickness (mm)
L28-W2	20	280	4.4

Technical Specification

L28-W2

Electrical Characteristics						
Parameter	Value					Unit
Module Operating Voltage	21					V DC
Module Drive Current	150	250	350	400	500	mA
LED Drive Current	50	83	116	133	166	mA
DC Power / Module	3.2	5.3	7.3	8.4	10.5	W

Optical Characteristics										
Product Code	LED Colour		CCT (K)	Module Luminous Flux (lm)*					Angle (°)	Min CRI
				150mA	250mA	350mA	400mA	500mA		
L28-W2-W	<input type="checkbox"/>	W	6000	540	871	1185	1340	1631	120	80
L28-W2-NW	<input type="checkbox"/>	NW	4000							
L28-W2-WW	<input type="checkbox"/>	WW	3000							

W - Cool White
 NW - Natural White
 WW - Warm White

* Values accurate to within 10%

Wiring Options @ 350mA per module

1 Module



2 Modules

Parallel Operation

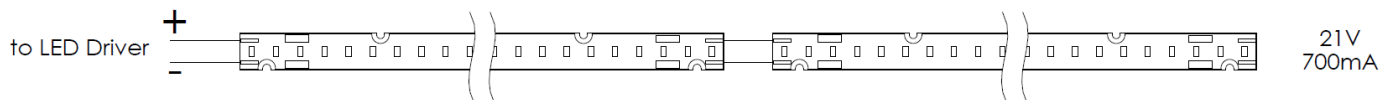

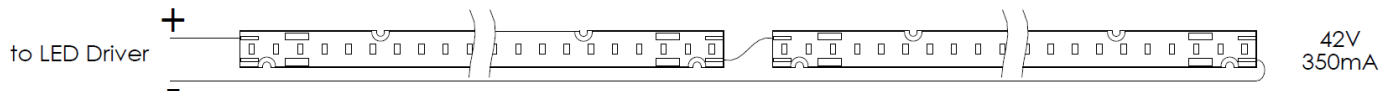

Series Operation

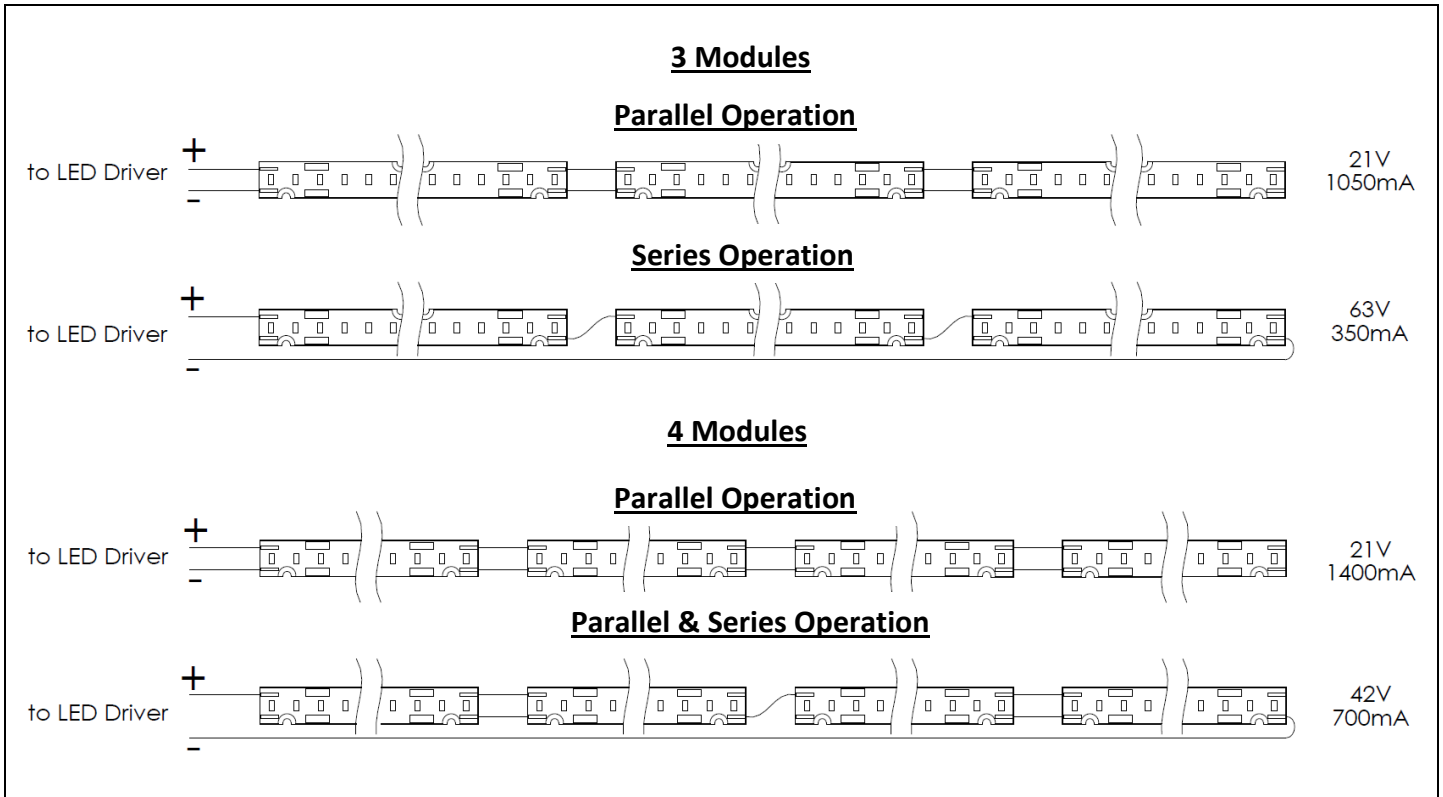

Technical Specification

L28-W2

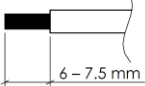
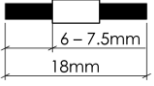

Wire Selection		
Connector Type	Recommended Wire Gauge	Recommended Wire Length for Board to Board Connection
 <p>Wago 2059 Series</p>	<p>0.14 – 0.34 mm² AWG 26 – 22 solid core Strip length: 6 – 7.5mm</p>  <p>6 – 7.5 mm</p>	<p>18 mm Strip length: 6 – 7.5mm</p>  <p>6 – 7.5mm 18mm</p>

Product Ordering Code				
Example: L28-W2-NW				
L28-W2	NW			
Product Code	Natural White LED Colour			

Document Info
L28-W2 Rev 2